

PRODUCT DETAILS

The Bianco NXT ECJet45 is a high quality, self-priming, composite jet pump fitted with an internal venturi which enables water to be drawn from below the pump centreline.

Supplied prewired with the award-winning Bianco NXT PRO controller, the user can choose between pump operating modes making MULTI-SP the perfect solution for for domestic household supply, water transfer or light irrigation / horticultural use in rural and semi-rural applications.

APPLICATIONS

- Household water supply – small dwellings
- Light garden irrigation
- Water transfer
- Washing systems
- Pressure boosting

FEATURES

- Pre-wired, dual mode, auto-restart pump controller
- Digital display
- Dry-run, frequent start, maximum run time protection
- Automatic pump starting, stopping and restart after power loss and/or water loss
- Corrosion-resistant pump body, diffuser and impeller to ensure pump durability
- High quality bearings and mechanical shaft seal
- 240V single-phase TEFC motor with inbuilt auto-reset thermal overload to prevent the pump from overheating



TECHNICAL DATA

OUTPUT POWER (P2)	0.45 kW
MAX. HEAD [M]	40 m
MAX. FLOW [LPM]	40 L/min
MAXIMUM PRESSURE	Pump 8 bar, Controller 10 bar
LIQUID TEMPERATURE	2 – 40°C
MOTOR	Asynchronous TEFC
MOTOR INSULATION	F Class
MOTOR PROTECTION	Inbuilt thermal overload
PROTECTION CLASS	IPX5
PRESSURE TANK	0.3L controller volume 3, 8 or 18L recommended

RATED VOLTAGE	220–240V 1ph 50Hz
RATED CURRENT	2.7 A
CAPACITOR	12µF 450Vc
POWER CABLE	1.5m long 10 A-rated H05 flex 10A 3-pin plug
AUTOMATIC OPERATION	Yes – NXT CORE
PUMP BODY	Composite
INTERNALS	Composite impeller / diffusers
MECHANICAL SEAL	Silicon Carbide/Carbon
PACKAGE DIMENSIONS	L485 x W250 x H462mm
GROSS WEIGHT (KG)	9.6 kg

CURVE

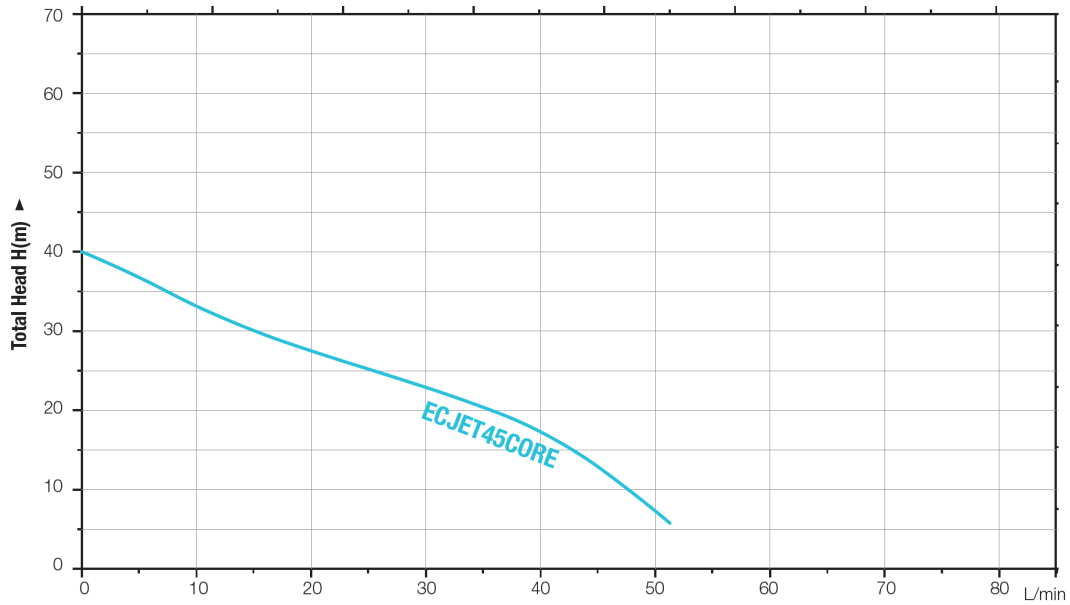

DIMENSIONS

Height incl Controller

Approx 420mm

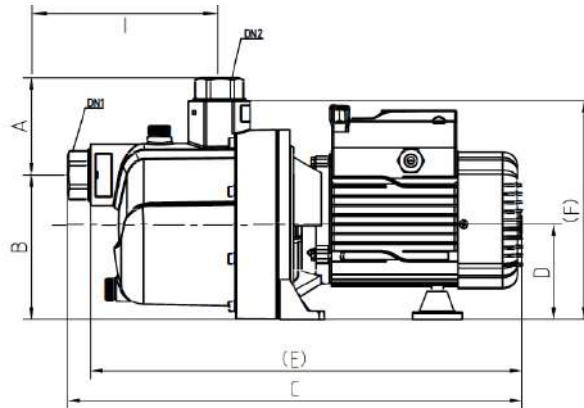

A	B	C	D	(E)	(F)	G	I	Dn1	Dn2
98	146	429	96	406	221	191	153	G1"	G1"

WARRANTY / CERTIFICATIONS

